

# B190

# JUM JUM

## 跳跳椅 | fun to jump together with music

### CONCEPT

擺脫以往兒童座椅玩具僅單一位兒童使用，將兩個跳跳椅做連接，以增加跳動困難度，讓孩童學習分享做椅，以及合作互動之精神；每種顏色的座椅，在彈跳時都會發出不同的聲音，孩童可以選擇自己喜愛的顏色，與其他孩童一起連接，在互動中也可像彈奏樂器一樣的有趣；也可變換弧形，形成彩色的樣子，也可刺激孩童對色彩的敏感度。

### 設計動機

從父母調查當中得到的結果是，會選擇購買座椅玩具是因為想讓孩子自己玩，不想讓孩子打擾到父母親。透過這點，想改變這種只能單人玩樂的座椅，讓孩子一樣是在玩，但是多了一個可以與其他孩童分享的方式。此玩具也可以與父母一同分享玩樂。

### 族群設定

3~7歲兒童 (3歲以下兒童對於支體掌控還尚未熟悉)

1

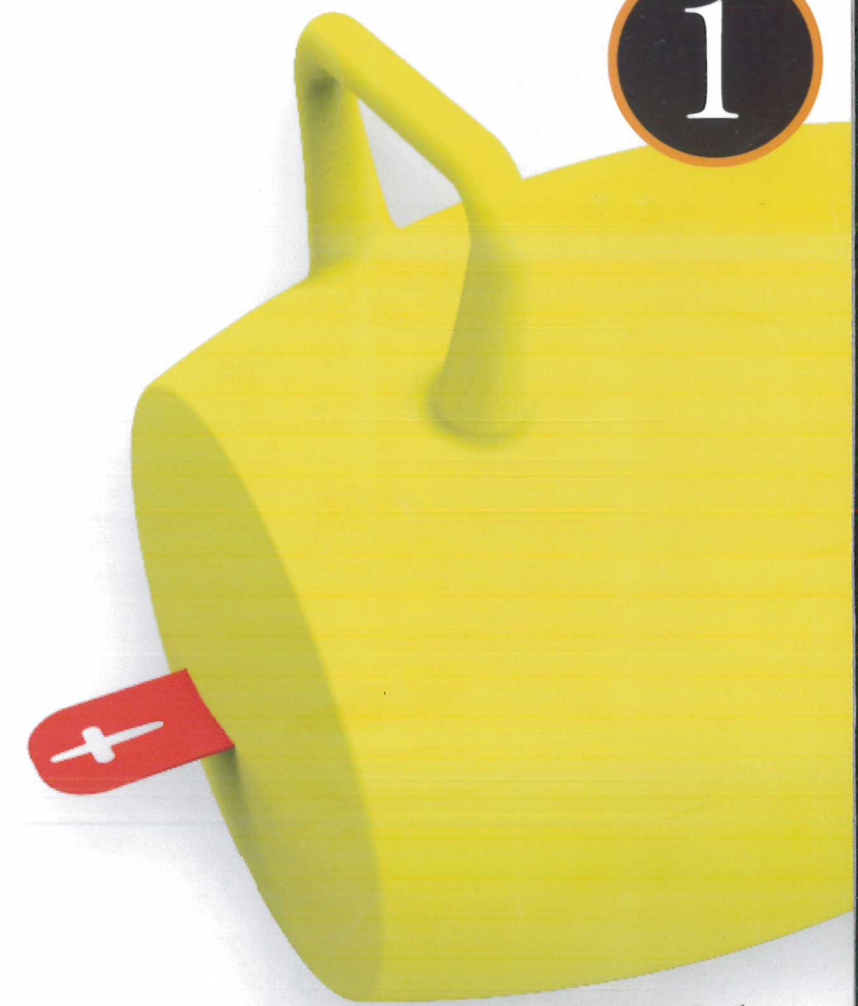

- chair design -





前面十字PVC銜接扣



後面PVC銜接條+塑膠圓棒

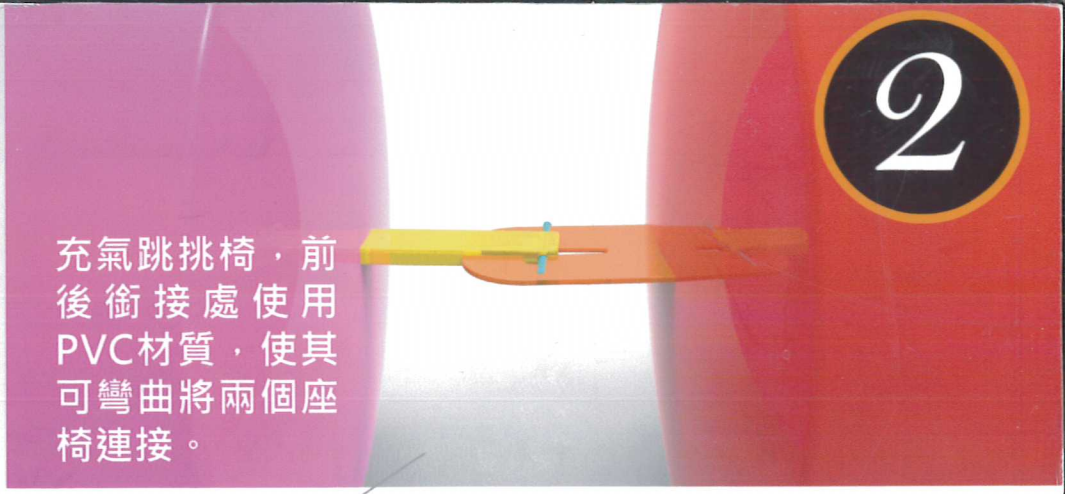

充氣跳挑椅，前後銜接處使用PVC材質，使其可彎曲將兩個座椅連接。

設計特點

- 1. 充氣跳挑椅，前後銜接處使用PVC材質，使其可彎曲將兩個座椅連接。
- 2. 不同顏色的座椅，會因為氣嘴的不同而發出不同的聲音，在互動中也可像彈奏樂器一樣的有趣。

外型尺寸

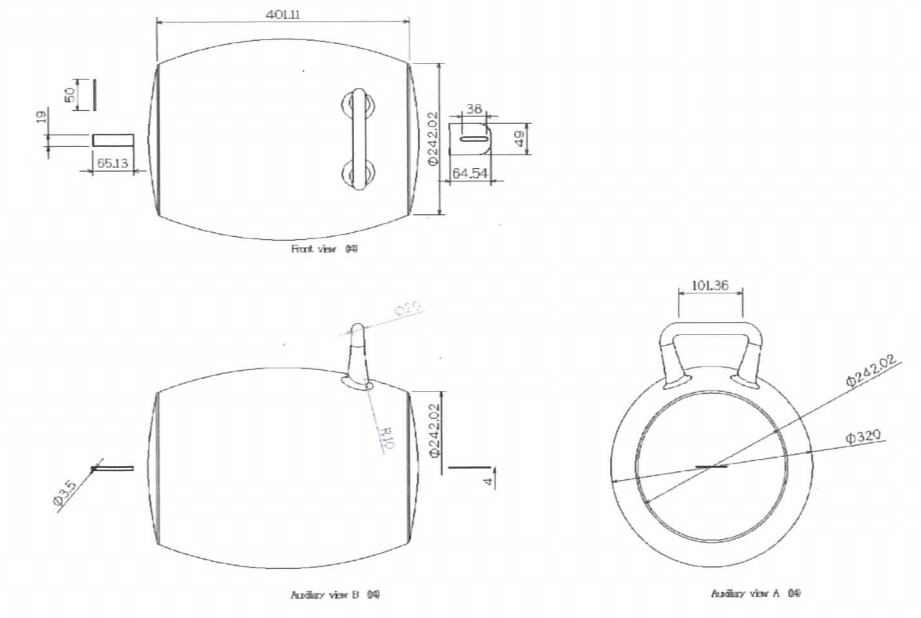

三面精描



JUM 

JUM 

fun to jump together with music



連接操作步驟

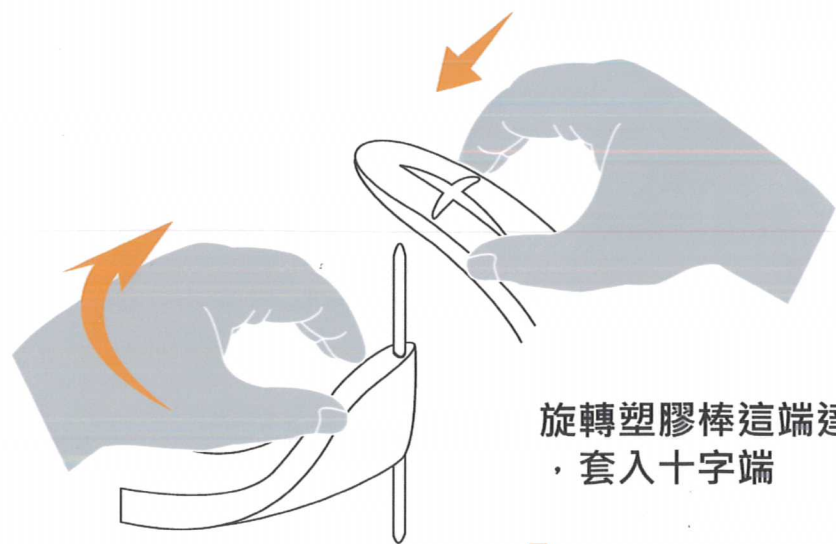

旋轉塑膠棒這端達垂直，套入十字端



套入後，在旋轉至平行即可完成前後銜接



fun to jump together with music .

3

充氣變化過程

氣充飽後，孩童就可以開始玩囉！  
不同顏色的座椅，會因為吹嘴形狀的不同在下壓的時候發出不同的聲音。

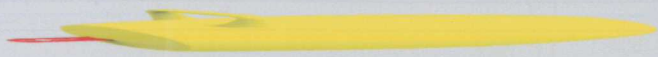
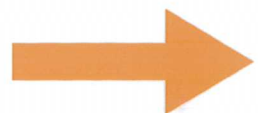

NO AIR



AIR IN

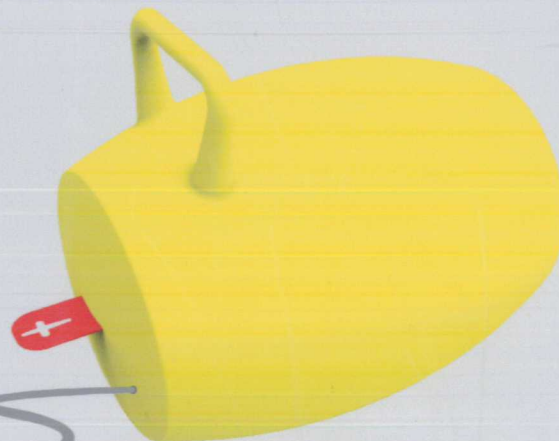

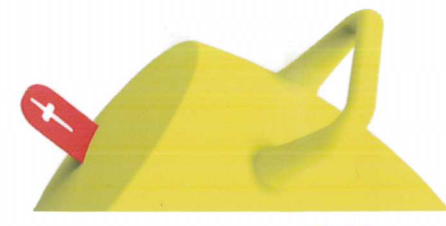

# JUMBO JUMBO 跳跳椅

fun to jump  
together with music



OUTDOOR



INDOOR



connect playing together